

HEWLETT-PACKARD JOURNAL

Cover: LASER-INTERFEROMETER CAMERA FOR IC MASKS; page 5

See Also: INTRODUCING IC's IN HP INSTRUMENTATION; page 2

INTEGRATED-CIRCUIT COUNTERS; page 9

SEMI-AUTOMATIC SYSTEM FOR PRODUCTION TESTING; page 14

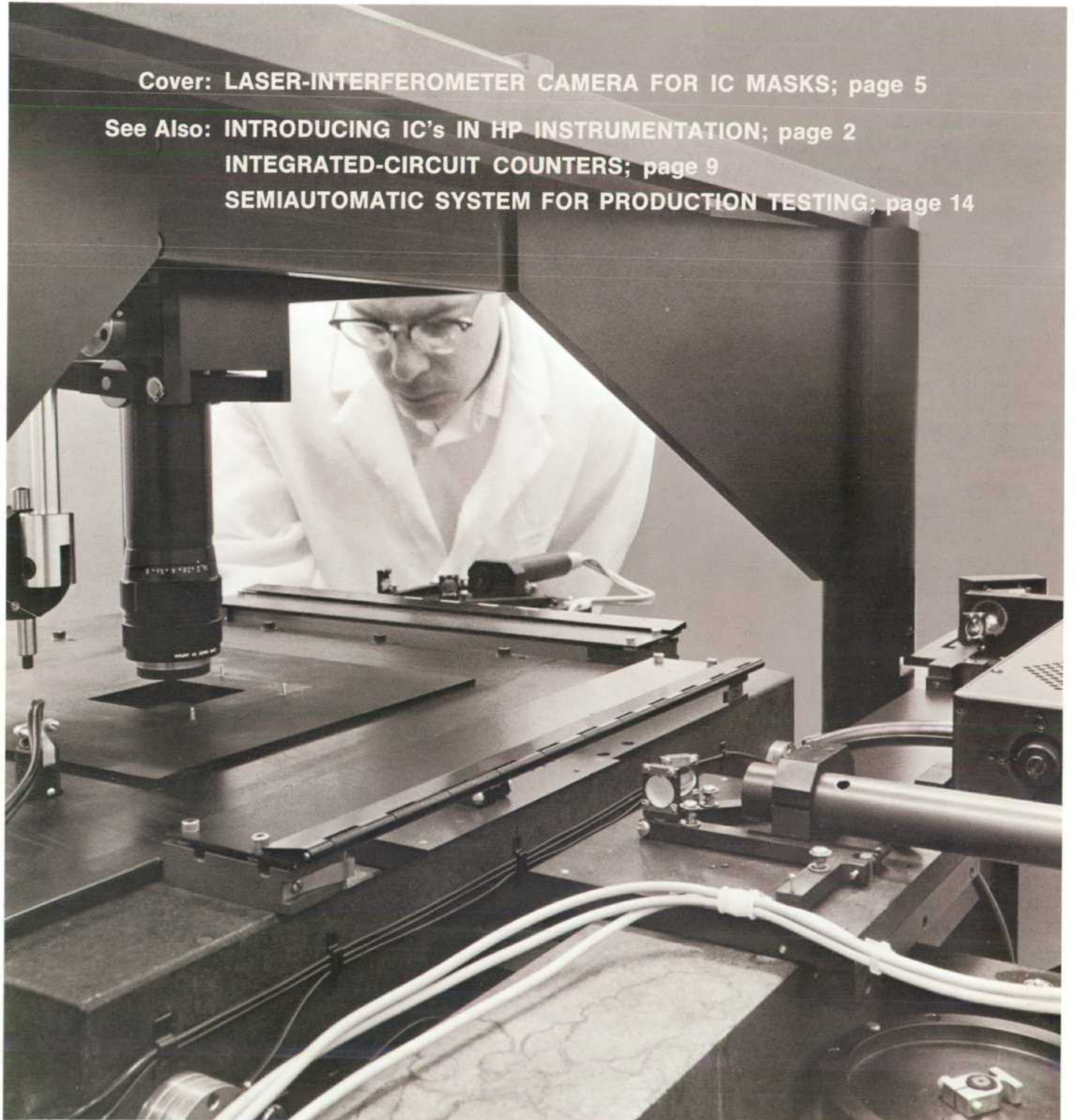

AUGUST 1967

© Copr. 1949-1998 Hewlett-Packard Co.

Implementing Integrated Circuits in HP Instrumentation

Some of the problem areas that Hewlett-Packard considered before introducing integrated circuits into instrumentation.

By Ian T. Band, Ed A. Hilton and Max J. Schuller

INSTRUMENT MANUFACTURERS, contemplating changes that integrated circuits will bring, must resolve a number of problems posed by the existence of integrated-circuit technology. On the one hand there exists a great potential of IC's in reducing instrument size and cost. On the other hand, there is a disparity between large-scale production for which IC's are well suited and lesser-scale production that prevails in the instrumentation field.

Another problem is the need for close communication between the circuit designer and the IC producer, a need that is important when specialized circuitry often needed for instrumentation is involved. Again, to produce instrumentation based wholly on off-the-shelf IC's would restrict the capabilities of the end-result instruments. However, an in-house IC production capability for custom-designed IC's requires substantial capital expenditure. Nevertheless, many benefits can accrue to the instrument user if custom IC's can successfully be introduced into the instrumentation field.

HP IC Program

One of the first needs met at Hewlett-Packard in undertaking an in-house IC program was fundamentally a problem of methodology. This need, already mentioned, is to achieve short communications channels between the circuit designer and the IC designer and producer. The solution was found, first, in taking the time and effort required to teach HP circuit design engineers techniques they needed to know to be able to execute circuit designs in a form compatible with IC methods, and, second, in arranging to perform all IC circuit design work in the conventional circuit-design laboratory. This approach was combined with a decision to develop an in-house facility for producing proprietary IC's to enhance the aim for short, direct communications paths. Being tailored to produce only proprietary designs, such a facility

can be of moderate proportions. The designer can rely upon commercial suppliers for the standard 'off-the-shelf' integrated circuits.

Under the system developed at HP, the full design weight (and flexibility) continues to rest with the circuit designer. He retains the responsibility for devising a design electrically suitable and assumes responsibility for a practical, producible IC. In fact the circuit designer generates the drawings from which the masks are made.

To give circuit designers the skills needed for designing IC's, about three hundred HP engineers attended courses of instruction in IC design. Such courses do not of themselves transform circuit designers into the experienced IC designers, so the courses have been supplemented with the services of advisory IC designers with specialized experience. Within the laboratory, therefore, there is a strong central IC design staff whose skills can radiate to the individual circuit designers.

This program has now produced several instruments in the HP Frequency and Time Division laboratories and has reached a stage of maturity in which its practicality is established. For example, the program has resulted in new frequency counters that incorporate a combination of advances. These counters have one to two orders of magnitude wider frequency range than the counters they replace, along with a substantial price reduction. Also, the counters are about 60% smaller in volume and incorporate a new user convenience, suppressing unneeded zeroes in the counter readout. This feature could, of course, be incorporated in non-integrated-circuit counters but at a noticeable cost increment, while in the new counters it was achieved using IC methods at virtually no additional production cost.

Besides these achievements, there are other, but less apparent, advantages that have proved important in the design phase. For example, it has been possible to arrange the lead layout for best electrical performance and for convenience in production. No multi-layer printed-circuit boards have been used. By locating the leads and the IC's so that conductor paths between the IC's contain no crossovers, board style has been limited to the standard double-side board.

Again, with IC design conducted in the circuit labora-

Cover: Designed and built at the Hewlett-Packard integrated circuit facility, this new step-and-repeat camera uses the laser interferometer method of controlling mechanical positioning to high orders of accuracy. See the article starting on page 5.

Integrated Circuit Design Procedure

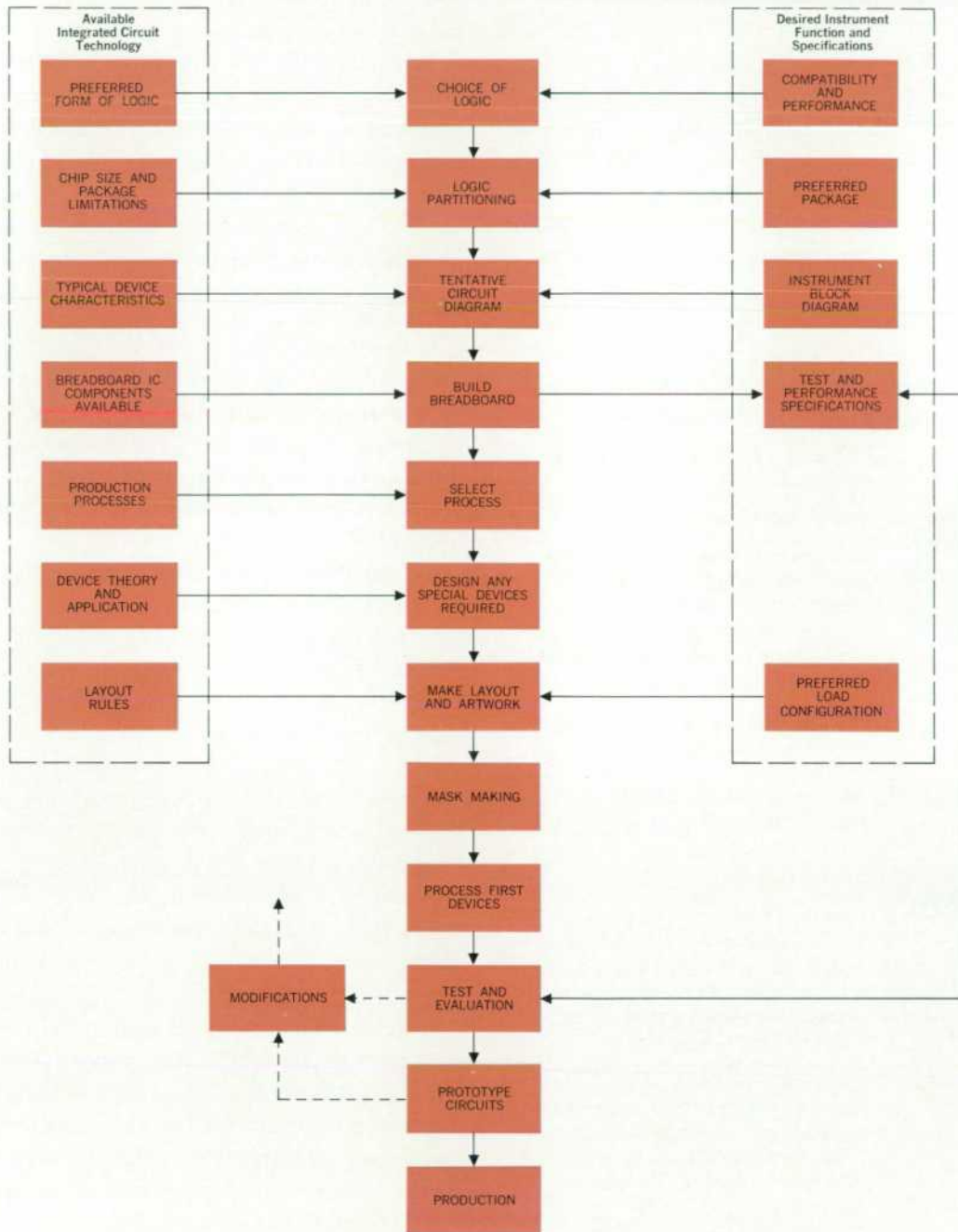

tory, it has been possible to reduce the elapsed time of the design-to-production cycle of an instrument by a factor of two or more. Where instrument design and tooling usually have had to be deferred until circuit design was at least in a breadboard stage, these steps were scheduled and executed concurrently.

IC Technology

In setting up the IC technology, care was taken to rely on established processes with a known history of repro-

ducibility and reliability. The logical choice in this respect was oxide-passivated silicon monolithic bipolar IC technology. This technology gives the instrument designer wide latitude as to circuit power, speed and function. Also, established techniques were used for packaging, such as TO-5 metal cans and dual in-line plastic packages.

Developmental circuits as well as production circuits are produced in the regular production manner, making turn-around time for the circuit short and unit cost of the

first circuits not much above that of subsequent batches. In addition, developmental circuits may be expected to have the same reliability as production circuits.

Designer Transition

One of the most difficult steps for the designer making the transition from designing with discrete components to designing IC's has been found to occur after he has a working breadboard of his desired circuit, and is ready to venture into the technology associated with making IC's. Up to this point the steps and design methods have been relatively familiar. At this point, however, the designer is faced with an unfamiliar array of materials, processes and devices. He must learn a new set of rules and techniques before he can translate his breadboard circuit into a usable set of IC mask drawings.



Ian T. Band

As a member of the HP Frequency and Time Division, Ian Band designed the first HP integrated circuits. He joined HP in 1965 and is presently the section leader for the F & T Division IC design staff.

Ian attended the University of St. Andrews in Scotland, receiving the B.S. and M.S. degrees. He worked several years each in Scotland and the U.S. before joining HP.



Ed A. Hilton

Ed Hilton has been with HP virtually all of his professional career. He joined HP in 1948 and has worked on the design of several types of instruments including frequency counters (522A) and fast electromechanical printers (560A).

More recently he has served as the manager of the HPA photoconductor laboratory and at present is the manager of the F & T Division IC facility.



Max J. Schuller

The technology employed in the F & T Division IC facility has been under the guidance of Max Schuller, technical director of the facility. Max was born in Germany and received the Dipl. Ing. degree in physics at the Technische Hochschule, Munich. He worked for a time in Europe and for some years on IC theory, design and technology in the U.S. before joining HP in 1965.

This post-breadboard stage is the point at which the IC staff may render some of its most valuable services, both as to technology and in generating confidence in the designer to continue.

It is evident that some qualitative understanding of the processes to be used and some knowledge of device design methods will help produce better circuits and avoid many pitfalls. However, except in a few specialized cases such as the high-voltage HP display driver circuits, a detailed knowledge of device theory is not really required as long as a device engineer is available for assistance.

Other Problems

It is important that the IC designer be aware of the numerous parasitics possible in a complex IC. Circuits have consisted of up to 100 components, and the interactions can be many. The problems of parasitic capacitance, inductance and resistance are usually well understood, but unwanted diode and transistor effects may be overlooked.

On the other hand it has been found that the designer has relatively little difficulty in devising his circuits so that they comply with the basic restrictions imposed by IC technology. Designers have not, for example, found difficulty in designing with a limited range of components or in adapting these designs to the wider parameter tolerances. In other instances more radical changes in philosophy are involved such that many transistors may be used to avoid a single capacitor or that the cost of any component is ultimately determined by the space it occupies on the silicon wafer. However, once he understands these new rules, the designer may have considerably more flexibility in his approach to the circuit design than before.

In some critical areas the circuit designer has had no choice but to rely on the experienced IC staff. Such factors as optimum chip size, component geometry and diffusion parameters for the best compromise between performance and yield have to be constantly re-evaluated against changes in the rapidly-expanding technology, and made known to the circuit designers.

Changes in instrumentation due to the use of IC's will not be limited to increases in performance and decreases in selling price. Rather, new levels of instrument capability and automation are on the horizon which will lead to new degrees of sophistication in measurement.

Acknowledgments

Many people were involved in setting up the Frequency and Time Division IC manufacturing capability, but especially Robert E. Brown, Edward C. Browning, Jack L. Hines, Kent Nakata, and Charles Oveland. ■

High-Accuracy Laser-Interferometer Camera for IC Masks

By Don M. Cross

HIGH YIELD IN INTEGRATED CIRCUIT PRODUCTION is dependent upon the accuracy of the photomasks employed in wafer fabrication. Each photomask consists of many high resolution images placed on a glass plate with high positional accuracy. The step-and-repeat camera is the precision tool used in mask fabrication.

Mechanical positioning in a new HP step-and-repeat camera is controlled by interferometer methods using a monochromatic light source. The interferometer optics split the light beam into two beams, then recombine the beams by means of mirrors to produce interference patterns. The counting of the light and dark fringes controls

position with precision of the order of better than half the wavelength of the light source.

The laser-interferometer controlled step-and-repeat camera developed by HP for use in the HP integrated circuit facility is shown in Fig. 1. It is one of the first cameras to take advantage of the high stability and coherence of laser light and put it to use on a production basis.

Typically, more than 100 and perhaps more than 500 individual IC's are formed on a single semiconductor wafer, each from the mask. Each IC may consist of 50 or more discrete circuit elements such as transistors, diodes,

Fig. 1. Laser-interferometer camera for integrated circuit production is capable of positioning an image within 0.3 micron anywhere in its field in a step-and-repeat pattern. Reversible counters in the rack, right, and programming circuits control a servo system for fully-automatic operation.

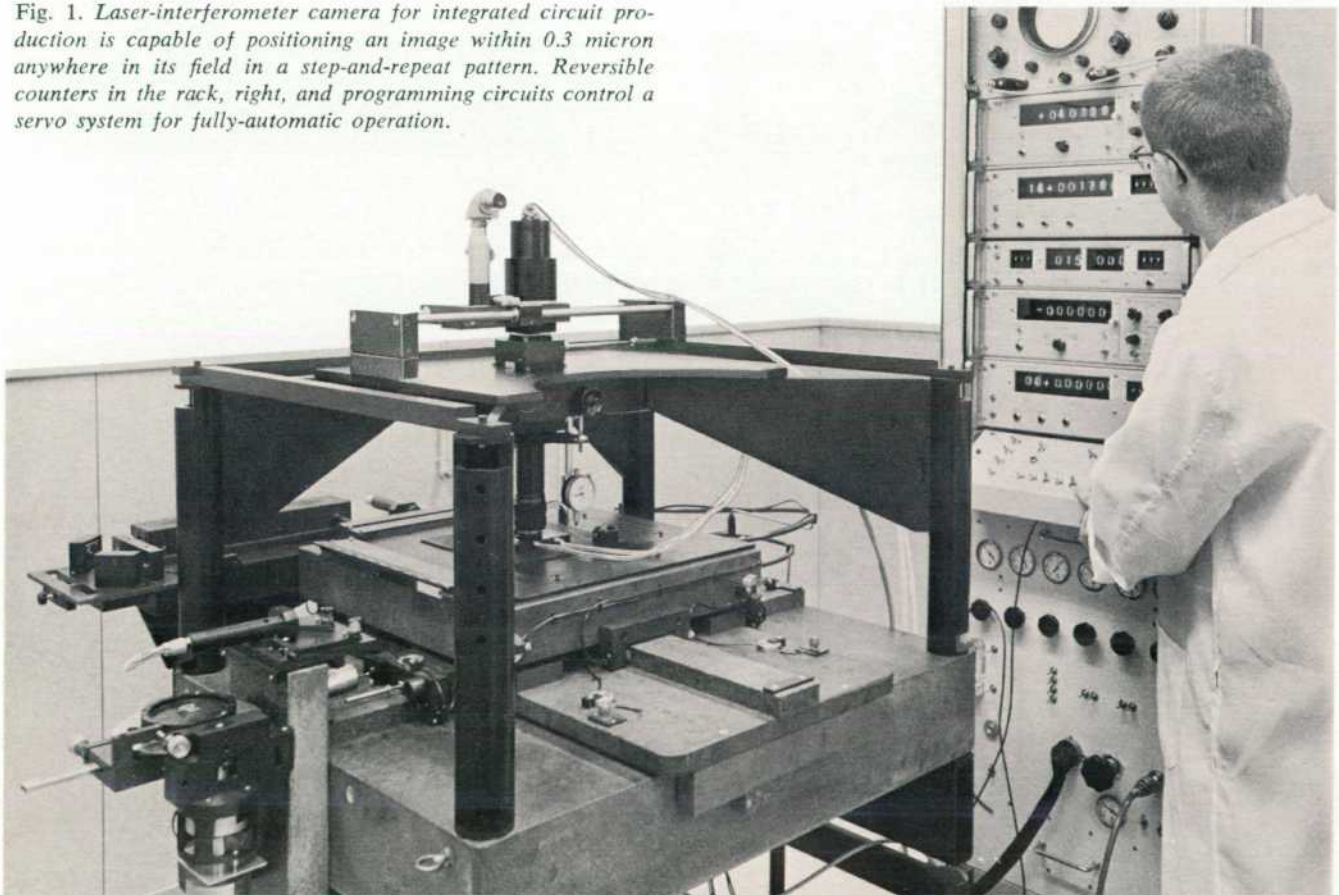

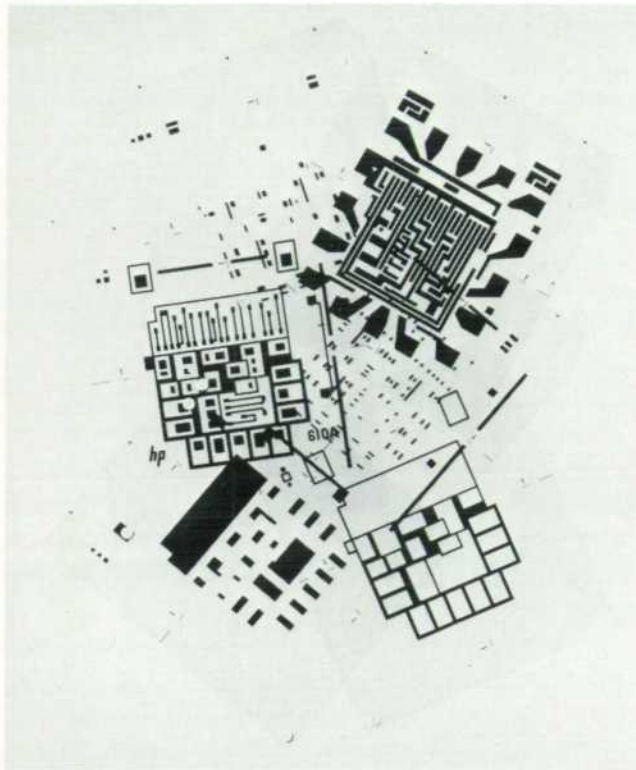

(a)

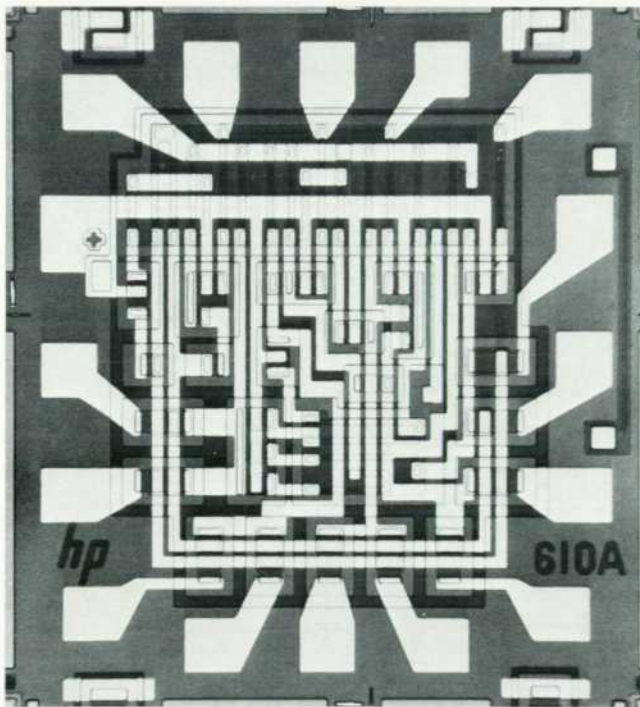

(b)

Fig. 2. Several masks (a) are generally used for the various processing steps in fabricating an integrated circuit. These masks, used in processing the Nixie driver circuit (b), must be positioned with high accuracy.

and resistors together with their interconnecting lines Fig. 2(b). The mechanical dimensions of the various conductors and areas comprising these individual elements become very small—dimensions in the final circuit are often in the micron (10^{-6}m) range. Of course, this compactness of circuitry is itself one of the appeals of IC's both for space-saving reasons and for high-frequency circuitry. But this same smallness presents problems requiring considerable care in IC production.

Fabricating Methods

In the process of fabricating monolithic integrated circuits with present techniques, it is necessary to expose photographically a suitable coating placed on the semiconductor wafer to a succession of five or more working masks, Fig. 2(a), during the various stages of processing. These masks, which are themselves photographic plates, involve images with line widths of the same micron-range dimensions described above. Obviously, for the various masks to be capable of proper superposition, it is necessary that all corresponding points on each of them be accurately in register within tolerances considerably smaller than the small line width, i.e., tolerances small compared to a few microns.

Because of these considerations, the IC mask-making procedure uses positioning equipment with accuracies that are near the limit permitted by the state of the art. These machines, used in combination with a high-quality camera system, expose onto various photographic plates the five or more master masks that are required. Each mask usually must be exposed on one plate in a step-and-repeat manner as many times as there are to be IC's on the wafer, and each of these exposures must be accurately in register with its counterpart on each plate. After photographic processing each plate becomes a master from which working masks are made.

At Hewlett-Packard, the inherent precision of the laser interferometer led to the use of such an interferometer in the step-and-repeat camera as an alternative to the mechanical positioning schemes used previously.

In the laser interferometer camera, the position of the working mask in the horizontal plane with respect to a reference point can be easily and precisely determined to an accuracy of one-half wavelength of the laser light. In the case of the HP machine, which uses a helium-neon laser, the wavelength (6328 Angstroms) permits positioning accuracy of 12.5 microinches or 0.3 micron. This accuracy is essentially constant for all points over the entire usable surface of the mask (and hence over the surface of the semiconductor wafer later imprinted from

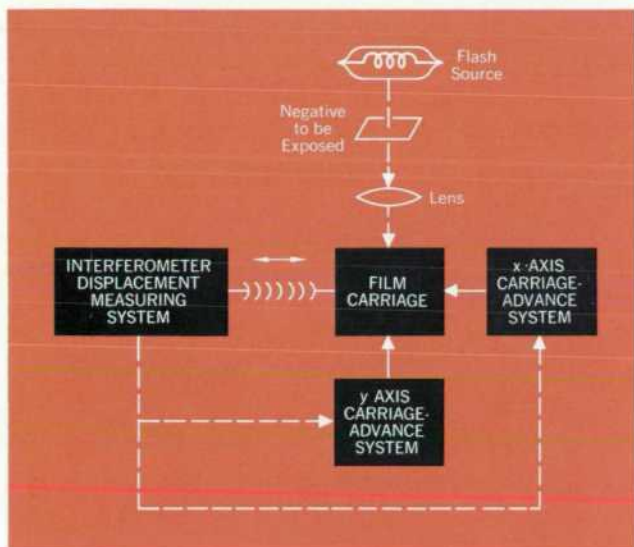

Fig. 3. The camera interferometer system actuates servo motors in the x and y axes to position the film carriage.

right angle in the setting of the reflecting mirrors. This gives rise to slight lack of parallelism in the plane wavefronts in the recombined beam, producing wave interference effects visible as fringing. As the position of the movable mirror changes, these fringes move laterally across the beam. Thus when the recombined beam is directed to a photodetector while the mirror is moving, the photodetector will produce a signal proportional to the light and dark bands. One fringe is produced for each laser half-wavelength of mirror movement, enabling the change in the position of the mirror to be measured very accurately by counting the number of fringes generated.

In practice, the system senses the direction of motion by using two photodetectors instead of one. The recombined beam is split with a chisel-edged mirror which directs one side of the beam to one photodetector and the second side to the other. Since the light intensity on the two sides of the beam is usually unequal because of the fringes, the voltage from the photodetectors will also be unequal. Adjustments can be made so that the fringe signals incident on the photodetectors are in quadrature, and the outputs from the two photodetectors will also be in quadrature. These outputs are applied to an HP Model 5280A Reversible Counter. The quadrature relation of the signals enables the counter to measure the net linear displacement of the mirror in either direction. By starting

it). The above accuracy does not necessarily represent the ultimately attainable performance of this type of system but was readily achieved and is more than sufficient.

Camera Operation

Positioning of each image and exposing of the photographic plate, is entirely automatic. The carriage bearing the photographic plate, Fig. 3, to be exposed is advanced in step-and-repeat fashion under control of the laser interferometer and a servo system. At each step an exposure is made from the master IC negative by flashing a light source. When the required number of exposures has been made for one row (the x axis), the carriage is indexed the proper amount in the opposite (y) axis and another row exposed. This process continues until the desired number of exposures has been made.

A more detailed diagram of one axis of the camera system is shown in Fig. 4. In the Michelson-type interferometer that the system uses, the coherent light from the stabilized laser is directed to a mirror attached to the movable carriage holding the photographic plate. At the same time, part of the light in the laser beam is split off by a half-silvered mirror and directed to a non-movable mirror. The reflections from the movable and non-movable mirrors are then directed back to a photodetector arrangement. The overall system then has one beam path of variable length and one of fixed length.

The cross-section of the recombined beams is not uniform but instead contains light and dark fringes, Fig. 5. The fringing arises from slight departure from a true

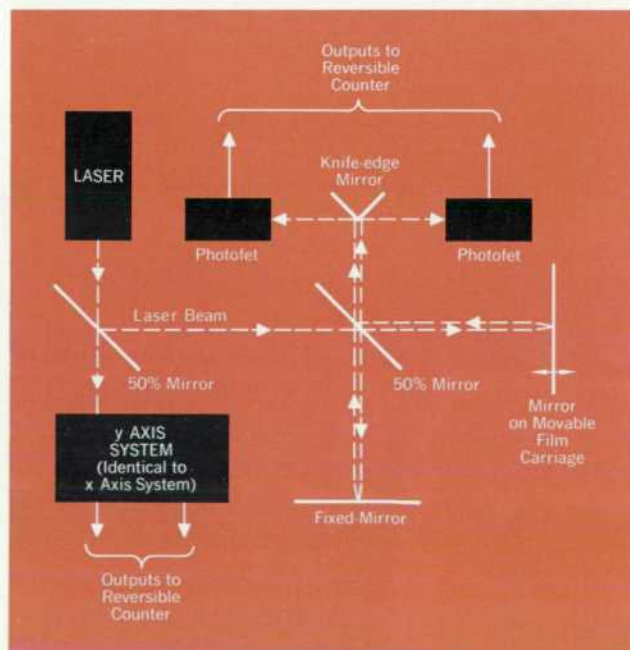

Fig. 4. In the interferometer system, the laser beam is reflected back upon itself to produce light and fringes one-half wavelength (of the light source) apart.

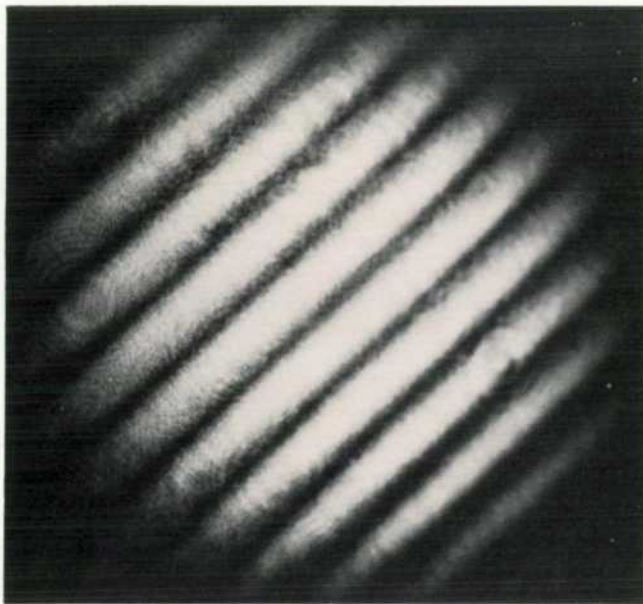

Fig. 5. A typical fringe pattern produced when the laser beam is recombined. If one beam path length is changed, the fringe moves laterally across the beam.

the mirror from a suitable reference point, then, it is possible to count the number of half-wavelengths the carriage has moved, thereby reading out on the counter the absolute position of the carriage in one horizontal axis.

A second interferometer system is used to control the carriage in the second axis of the horizontal plane.

Control System

In the servo system, the voltage from the photodetector is amplified, shaped into a square wave, and applied to an HP Model 5280A Reversible Counter which continuously displays the position of the carriage from the reference line. When a row of exposures has been made, the



Don M. Cross

After joining HP in 1960, Don Cross worked in the test section of the HP Microwave Division. Later, he was assigned the designing and building of specialized in-plant test equipment for HP Associates.

More recently he has been designing and constructing the special test equipment needed for the F & T Division IC facility, and in this connection has developed the control system for the laser-interferometer camera.

counter produces a signal so that the carriage will be indexed to the next row.

The shaped waveform from the photodetector is also applied to one additional channel which subtracts the fringe count from a preset number. When the difference between these two numbers is zero, the carriage is in the proper position for an exposure, and a xenon flash tube is fired to expose the negative onto the proper place on the photographic plate.

In order that the carriage speed be low when the exposure is made (to avoid image blurring), a rate-sensing circuit provides a control signal proportional to the speed of the carriage. This signal along with other signals is sensed by the motor speed control circuitry so that the speed of the plate carriage can be slowed in anticipation of reaching the actual point at which exposure is desired. With this arrangement, the exposure (about a millisecond) can be made by slowing the carriage rather than bringing it to a full stop. This method saves considerable time over a full-stop technique. After the exposure, the plate carriage is accelerated to higher velocity until the rate-sensing arrangement again decelerates it in anticipation of the next exposure.

The exposures proceed in this manner until the end of the (x) row is reached, as determined by a programmed counting circuit. The circuit then signals the carriage-indexing circuit and the carriage is indexed one step in the other axis (y), returned to the first position, and the process repeats. Exposures are thus made row-by-row under automatic control until the array is complete.

An important contribution to the performance of the camera is the air bearing arrangement which supports the carriage. Two bearing systems are used, one for linear movement in the x direction and one for the y. Suitable linear guidance arrangements are used with the air bearings to keep the relative directions of the two axes precisely orthogonal.

Overall Performance

The 0.3-micron accuracy of the camera is a constant accuracy and not affected by the position of the carriage. This accuracy gives the camera a high repeatability compared even to the small widths of the lines comprising the microcircuit. Accuracy is basically unaffected by wear.

Acknowledgments

The development of the camera system was greatly assisted by the contributions of Manuel Coronado. Walter Smith also assisted in establishing the overall photolithographic system. ■

Integrated-Circuit Counters

Here is a designer's-eye view of the impact of integrated circuits on electronic counters. Two new IC counters are described.

By Thomas P. O'Brien and John W. McMains

OVER NINETY PERCENT OF THE CIRCUITS in two new HP electronic counters are monolithic silicon integrated circuits.

As a result, these counters are smaller and lighter and consume considerably less power than comparable previous counters. They are also expected to prove more reliable. Yet they cost significantly less than non-integrated counters with similar capabilities.

Fig. 1 and the table below give a good introduction to the smaller of the two new IC counters—a four-digit instrument with a maximum counting rate of 10 MHz*—by comparing it with a vacuum tube counter and a transistorized counter. Each of the three counters is the lowest-priced HP counter of its type.

As circuits have changed from tubes to transistors to IC's, specifications have improved and prices have dropped (see table). Most notable, perhaps, is the increase in maximum counting rate in kilohertz per dollar, which has gone from 0.185 in the vacuum tube counter to 0.522 in the transistorized version to 21.0 in the IC unit.

The larger of the two new IC counters is a seven-digit, 12.5 MHz unit which can measure frequency, period, multiple-period average, ratio, and time interval. In Fig. 2 it is shown with a comparable vacuum-tube counter. Although the IC counter has capabilities similar to the

* Six digits (option 02) are required to count a maximum frequency of 10 MHz. With four digits, the maximum counting rate is 10 MHz, but the maximum displayed frequency is 99.99 kHz. The table shows the price and kHz/dollar figure of the six-digit counter.

basic vacuum-tube instrument, it is smaller than one of the plug-ins for the tube-type counter.

Custom Integrated Circuits

All of the integrated circuits used in the two new counters are monolithic, that is, each circuit is constructed on a single chip of semiconductor material. The counting and display chain for each digit consists of a decade counter, a buffer storage register, and a display tube driver. In the new counters, each of these elements is integrated on a single chip. Thus each counting and display chain has only three packages (one chip per package).

Five of the IC's for the counters were designed and built in HP's own integrated circuit facility. These circuits all contain features which are not otherwise available.

Comparing Counters

	521A (Vacuum Tube)	5211A (Transistorized)	5221A (Integrated)
Maximum Counting Rate	120 kHz	300 kHz	10 MHz
Weight	28 lbs	15 lbs	5 lbs
Power Required	160 watts	40 watts	12 watts
Price	\$650	\$575	\$475*
Max. Counting Rate in kHz/dollar	0.185	0.522	21.0*

With the capability of designing circuits to fit specific needs, it was possible to minimize the number of separate circuit packages, thereby aiming to simplify the construction, testing, and maintenance of the end product. As an example, take the decade divider used in the time bases of both counters. Using the same basic circuit design as the decades intended for the counting and display chain, we added the capability to selectively preset the time-base decade to either of two states, 0 or 9. (This is needed to minimize deadtime between gate periods.) Also we added a gated output such that divider ratios of 10, 100, 1000, etc. could be selected by an externally applied voltage level.



Fig. 1. Clockwise from left, HP Model 521A Vacuum-tube Counter, HP Model 5221A Integrated-circuit Counter, and HP Model 5211A Transistorized Counter. Counter specifications have steadily improved while prices and sizes have dropped.

These additions caused only a slight increase in the chip size and required no more external connections than the basic decade, yet they allowed the control circuitry of the instrument to be implemented much more efficiently. Several additional packages of logic circuitry

would have been necessary had we been limited to off-the-shelf integrated circuits.

Miniature Nixie® display tubes for the new IC counters were specially developed by the Burroughs Corporation. The IC display-tube driver circuits are of HP design. Using IC drivers eliminates the photoconductive decoding matrix formerly used to transfer information to the display. The IC drivers are smaller, and lower in cost; it also seems reasonable to expect reliability will prove higher, if experience with other IC's is a guide.



Fig. 2. HP Model 524A Vacuum-tube Counter and new HP Model 5216A Integrated-circuit Counter have comparable functions but very different sizes.

Off-the-Shelf IC's

Commercially available integrated circuits are also used in the counters. The control logic needed several gates and flip-flops that could be implemented by available off-the-shelf circuits. Texas Instruments' Series 74N line of transistor-transistor logic (TTL) is compatible with HP circuits. Hence we chose standard logic packages from that line wherever they could well be used. In the larger of the two counters there are six Series 74N packages and 29 packages of HP design; in the smaller counter the breakdown is three Series 74N units and 14 HP integrated circuits.

Zero Suppression

An innovation is the zero suppression capability featured in both new integrated counters. All insignificant

® Registered TM, Burroughs Corp.

zeroes (i.e. those to the left of the most significant digit) are suppressed and the columns at the left side of the display are dark until they have received a carry pulse from the preceding decade counter (Fig. 3). Although it conveys no new information, zero suppression provides a simplified and uncluttered readout with less chance for errors in reading the display.

Whether any given decade will have zero suppression at any given time depends on where the corresponding digit is in relation to the decimal point on the display. Digits to the right of the decimal point and the first digit to the left would not have their zero-suppression circuits enabled. There is also a rear-panel switch for overriding zero suppression in all decades. When a decade is not to have zero suppression it receives a control signal from logic circuitry which monitors the position of the decimal point and the rear-panel switch.

The state diagram, Fig. 4, shows how zero suppression works. Whenever a reset pulse occurs, the decade is reset into either state B—if it is to have zero suppression—or state 0. State B can only be entered if the control signal permits it and a reset pulse occurs. When a decade is in state B the first count pulse will send it to state 1. Thereafter it works like a standard decade, counting up to 9, then back to 0, 1, 2, and so on. The next reset pulse will send it to state B again.

The decoding portion of the IC Nixie driver interprets state B as a blank. Thus that digit of the display remains dark until a count pulse sends the decade to state 1.

Functional Design

There are three major assemblies in the smaller IC counter and four in the larger. These assemblies are re-



Thomas P. O'Brien

Tom O'Brien received his BS degree in electrical engineering in 1960 from the Polytechnic Institute of Brooklyn. His MS degree in electrical engineering was earned at the University of Santa Clara in 1964.

Before he came to HP, Tom designed circuits for microwave communications, mobile telephone, and digital data transmission systems. With HP's Frequency and Time Division since 1964, he has worked on the 5280A Reversible Counter and the 5285A Universal Plug-in, and was project leader for the 5221A IC Counter. He is now an engineering group leader in the counter section of the Frequency and Time Laboratory.



John W. McMains

John McMains came to HP in 1965 from Stanford University's Electronics Laboratories, where he was a research assistant. John received his BS and MS degrees in electrical engineering from Stanford in 1964 and 1966. He is a member of Tau Beta Pi and Sigma Xi.

At HP, John has worked on the 5280A Reversible Counter and the 5285A Universal Plug-in, and was project leader for the 5216A IC Counter.



Fig. 3. Zero-suppression feature of new IC counters makes digits at left of display dark when not in use. Older counters showed zeros in these columns and were harder to read.

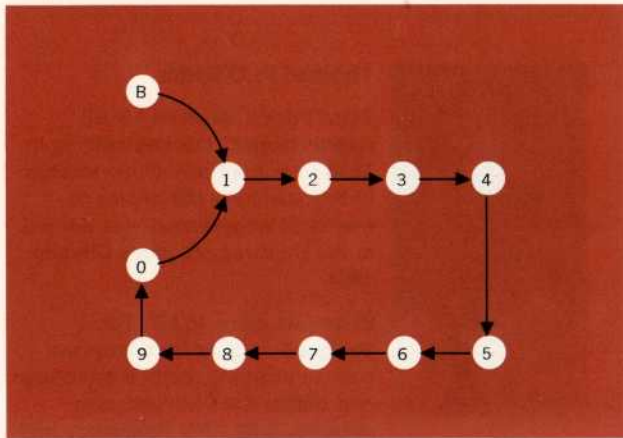

Fig. 4. State diagram for decade counter with zero suppression. Reset pulses send decade to state B, which causes Nixie tube to remain dark. First count pulse sends decade to state 1. Decade then counts in normal manner until next reset pulse.

lated as shown in Fig. 5. This functional assembly approach was taken to give the instruments a high degree of serviceability. Each assembly may be used independently of the others provided that proper interfacing is maintained.

In both counters, all counting, control, and readout circuits are on one removable board (see Fig. 6). This feature, with low price, suits the counter board as a component assembly which can be used in other instruments, such as programmable signal sources.

Discrete Components

We have relied on discrete components where it seemed reasonable to do so, especially in areas that must

interface with an external environment. The input amplifiers, for example, are discrete.

Design and testing of the input amplifiers was carried out with the help of computer-aided circuit analysis. IBM ECAP (Electronic Circuit Analysis Program) was a particularly useful tool.

Potential for Better Reliability

In electronic equipment the weak link is often the interconnections between components and assemblies.

One of the most reliable interconnects available is the thin film metallization used in forming the interconnect pattern of a monolithic integrated circuit. The reliability of the complete circuit function may then approach that of a single semiconductor device.

Every interconnection in a discrete circuit implies two solder joints, with associated risks. The number of solder joints in each of the IC counters is much smaller than the number of connections in a discrete instrument of equal capability. In the smaller counter there are only 36 solder interconnections in the entire instrument. In the larger counter, only 58 solder interconnections were necessary. This is less by a factor of 4 than a comparable transistorized instrument.

Acknowledgments

Many people have contributed to the realization of the integrated circuit counters. The integrated circuit facility under the direction of Edgar A. Hilton was obviously a vital part of this project. Ian T. Band, John H. Gliever, and Glade H. Lybbert were also instrumental in the development of the custom integrated circuits. George C. Kenney and Peter R. Roth contributed much to the electrical design of both instruments, while the mechanical design and packaging was the joint effort of Gaylen T. Grover and Leonard J. Kraska. ■

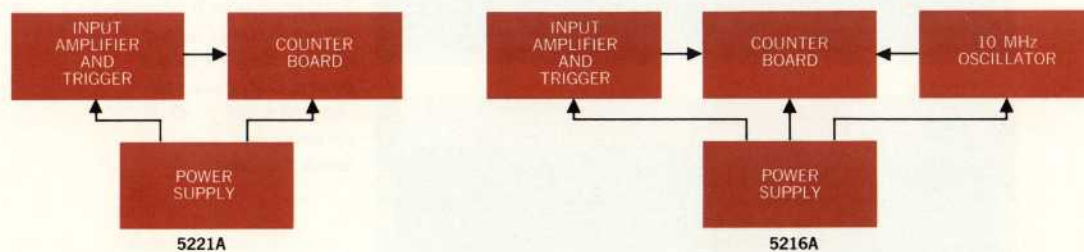
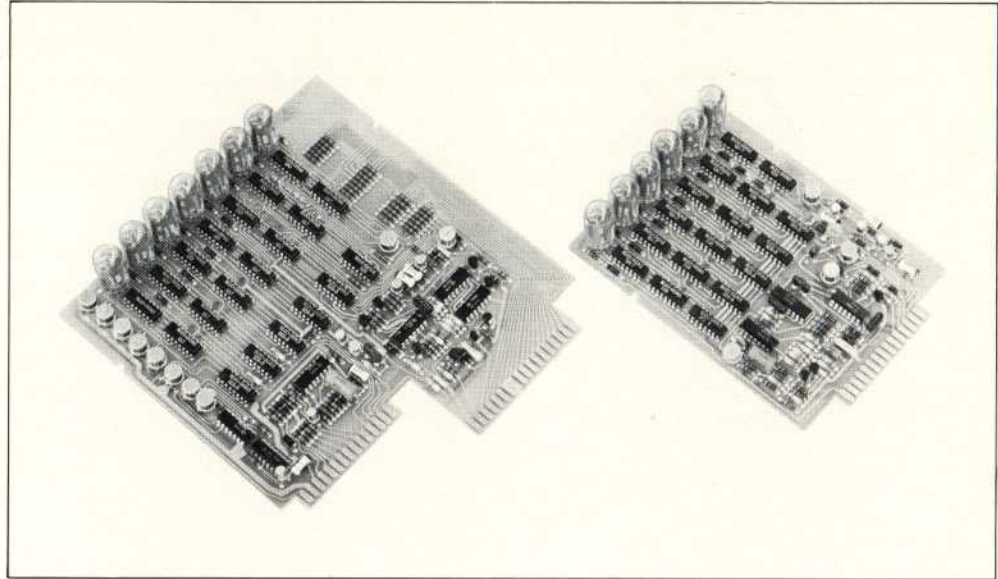

Fig. 5. HP Model 5221A Counter has only three major assemblies. Model 5216A has only four.

Fig. 6. Counter boards from Model 5216A Counter (l.) and Model 5221A Counter. All counting, control, and readout circuits are on these boards, which can be used as component counter assemblies in other instruments. Note that Model 5221A counter board (r.) has room for six digits. Four are standard, six optional.



SPECIFICATIONS

HP Model 5216A Electronic Counter

RANGE: 3 Hz to 12.5 MHz.

REGISTRATION

NUMBER OF DIGITS: 7

DISPLAY: Long-life Nixie® with display storage and blanking.
DISPLAY TIME: 50 ms to 5 s or hold until manual reset.

INPUT

SENSITIVITY: 0.01 V rms sine wave, max. sensitivity; 30 mV peak pulse, min. pulse width 40 ns. Front panel sensitivity control is a step attenuator (0.01, 0.1, 1, 10 V settings). A continuously variable trigger level control is also provided.
IMPEDANCE: Approx. 1 M Ω shunted by 50 pF.

OVERLOAD: Input voltage should not exceed 60 dB above attenuator setting or 300 V rms (damage level).

CONNECTORS: At both front and rear panels.
SIGNAL POLARITY: Front panel trigger level control allows counting either positive or negative input pulses.

OPERATING TEMPERATURE RANGE: 0°C to +50°C.

TIME BASE FREQUENCY: 10 MHz.

TIME BASE STABILITY

AGING RATE: $\leq \pm 2$ parts in 10^6 /month.

AS A FUNCTION OF TEMPERATURE: $\leq \pm 1$ part in 10^6 (+15°C to +35°C); ± 3 parts in 10^6 (0°C to +50°C).

AS A FUNCTION OF LINE VOLTAGE ($\pm 10\%$): ≤ 1 part in 10^6 .

EXTERNAL TIME BASE INPUT

SENSITIVITY: 1 V rms sine wave into 1000 Ω (10 V rms maximum).

RANGE: 1 kHz to 2 MHz, sine wave.

TIME BASE OUTPUT: 1 MHz, 3 V p-p minimum open circuit; source impedance is 2000 Ω .

FREQUENCY MEASUREMENT

RANGE: 3 Hz to 12.5 MHz.

SENSITIVITY: See INPUT.

ACCURACY: ± 1 count, \pm time base accuracy.

READS IN: MHz and kHz with positioned decimal point.

SELF-CHECK: Counts 1 MHz.

GATE TIMES: 10, 1, 0.1, 0.01 s.

PERIOD AND MULTIPLE PERIOD AVERAGE MEASUREMENT
RANGE: 3 Hz to 1 MHz single period; 2 MHz multiple period average.

SENSITIVITY: As under INPUT except 100 mV below 1 kHz.

ACCURACY: ± 1 count \pm time base accuracy, \pm trigger error.*

READS IN: Milliseconds and microseconds with positioned decimal.

PERIODS AVERAGED: 1, 10, 10², 10³, 10⁴, 10⁵.

FREQUENCY COUNTED: 1 MHz.

RATIO MEASUREMENT

READS: (f_1/f_2) \times period multiplier.

RANGE: f_1 : 1 kHz to 2 MHz into external time base BNC connector (min. of 1 V rms into 1000 Ω); f_2 : Same as period.

ACCURACY: ± 1 count of f_1 , \pm trigger error of f_2 .*

TIME INTERVAL: Activated by contact closure or saturated NPN transistor to ground of separate rear panel BNC's for START and STOP. Signal duration ≥ 1 μ s. Current sinking ≥ 2 mA. The START signal must end before the STOP signal begins. Time from STOP to START: ≥ 30 ms for external reset or ≥ 30 ms + sample time for internal reset.

Minimum Time Interval: 10 μ s. Counts 1 MHz internal time base.

REMOTE RESET: Activated by closure or saturated NPN transistor to ground of rear panel BNC.

BCD OUTPUT

CODE: 1-2-4-8, '1' state positive.

'0' STATE LEVEL: 0 V, open circuit, nominal.

'1' STATE LEVEL: 5 V, open circuit, nominal.

IMPEDANCE: 7.5 k Ω , maximum each line.

REFERENCE LEVELS: Ground; +5 V, low impedance.

PRINT COMMAND: Step from 0 V to +5 V, dc coupled.

HOLD-OFF REQUIREMENTS: -10 V maximum to -15 V minimum.

WEIGHT: Net, 7 lbs. (3.2 kg). Shipping, 8½ lbs. (3.9 kg).

POWER REQUIREMENTS: 115/230 V $\pm 10\%$, 50 to 1000 Hz, 20 W max.

PRICE: HP Model 5216A, \$925.

ACCESSORIES SUPPLIED: Detachable power cord, 7½ ft. (231 cm) long, NEMA plug.

* Registered TM, Burroughs Corp.

* Trigger error for 0.1 V rms sine wave input is less than $\pm 0.3\%$ of one period for signals with 40 dB signal-to-noise ratio, no. periods averaged

Decreases with increased signal amplitude and slope.

HP Model 5221A Electronic Counter

RANGE: 5 Hz to 10 MHz.

REGISTRATION: 4 digits (5 and 6 available); long-life Nixie tubes with display storage.

MAXIMUM DISPLAYED FREQUENCY: Standard model: 99.99 kHz; Option 01: 999.99 kHz; Option 02: 9.9999 MHz (decimal point and unit are not shown in display).

INPUT

SENSITIVITY: 0.1 V rms sine wave max. sensitivity from 5 Hz to 10 MHz.

PULSES: 200 mV peak voltage (internal control adjusts for positive or negative pulses) 50 ns minimum pulse width.

IMPEDANCE: Approx. 1 M Ω , shunted by 30 pF.

OVERLOAD: At maximum sensitivity, input should not exceed 3.5 V rms to retain rated input impedance. Damage level is 15 V rms. At minimum sensitivity damage level is 250 V rms.

ACCURACY: ± 1 count \pm power line frequency accuracy.*

SELF CHECK: Counts power line frequency.

GATE TIMES: 1 and 0.1 s.

GATE CONTROL: Controlled by manual GATE SELECTOR switch on front panel or by contact closure or saturated NPN transistor to ground on EXT BNC on rear panel with GATE SELECTOR switch in OPEN position.

DISPLAY TIME: Variable from a minimum of 50 ms to approx. 5 s or may be held until manually reset.

RESET TO ZERO: Automatic or manual.

OPERATING TEMPERATURE RANGE: 0°C to +50°C.

WEIGHT: Net, 5 lbs. (2.3 kg). Shipping, 6½ lbs. (3.0 kg).

POWER REQUIREMENTS: 115 or 230 V $\pm 10\%$, 60 Hz, 12 W max.

ACCESSORIES SUPPLIED: Detachable power cord, 7½ ft. (231 cm) long, NEMA plug.

PRICE: HP Model 5221A, \$350.

OPTIONS

01: 5-digit display, add \$75.

02: 6-digit display, add \$125.

5060-0797 RACK ADAPTER FRAME: The HP 5060-0797 rack adapter frame offers a simple and economical means of rack mounting ½ and ¼ module HP instruments. Filler panels and accessory drawer are available to fill unused space in the frame. Holds three Model 5221A Counters.

PRICE: HP 5060-0797 Adapter Frame, \$25.

* Line frequency is typically better than 0.1% for commercial power.

MANUFACTURING DIVISION:

HP FREQUENCY AND TIME DIVISION
1501 Page Mill Road
Palo Alto, California 94304

Semiautomatic System for Production Testing of Electronics Circuits

By Dee L. Larson and Emil E. Olander, Jr.

MANY AREAS OF INSTRUMENTATION require that a predetermined sequence of measurements be taken frequently. Among these are various assembly line tests, system check-out procedures, inspection and instrument calibration. They range from simple evaluation of single components to the sequential measurement of many parameters of a circuit, or of a complete system.

Measurements of this type are often simplified to 'Go' (in tolerance) or 'No Go' (out of tolerance). The 'No Go' reading may be broken down into 'High' and 'Low' readings for more detailed classification.

The 'Go' or 'No Go' decisions may be determined in a number of ways. In relatively complex systems, the

decision may require a computer whose inputs are supplied from a combination of voltmeters, counters, etc. In the simpler systems, a human operator may obtain each measurement manually.

Between the two extremes, that is between the highly sophisticated computer-type test systems and the manual tests, lies a large area suited to smaller automatic or semiautomatic systems which are simpler than the computer systems, but which require faster and easier operation than ordinary manual means. A moderately-priced automatic or semiautomatic system used in place of a manual arrangement can reduce operator fatigue, result in fewer measurement errors, reduce test time, and permit operation by less-experienced operators.

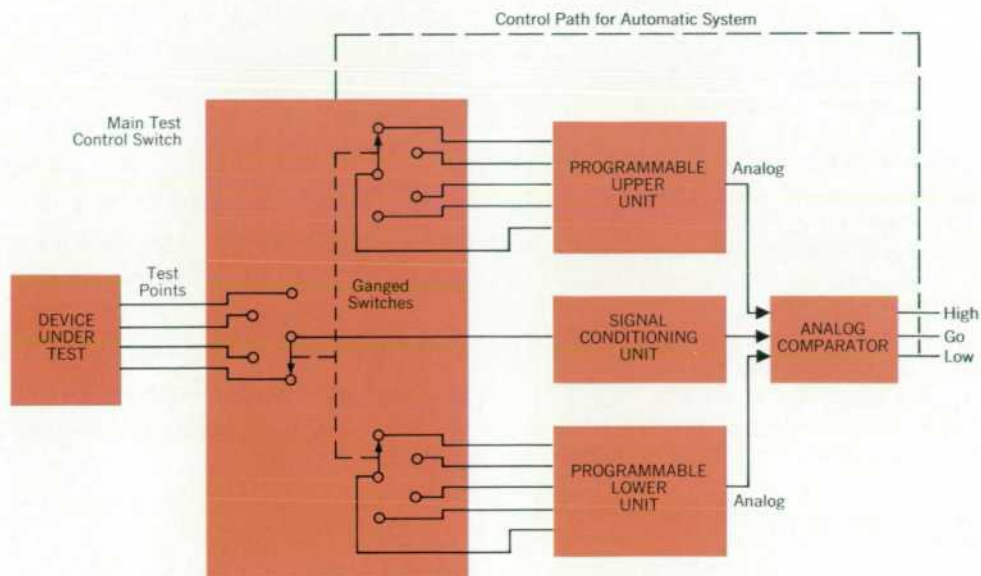

(a)

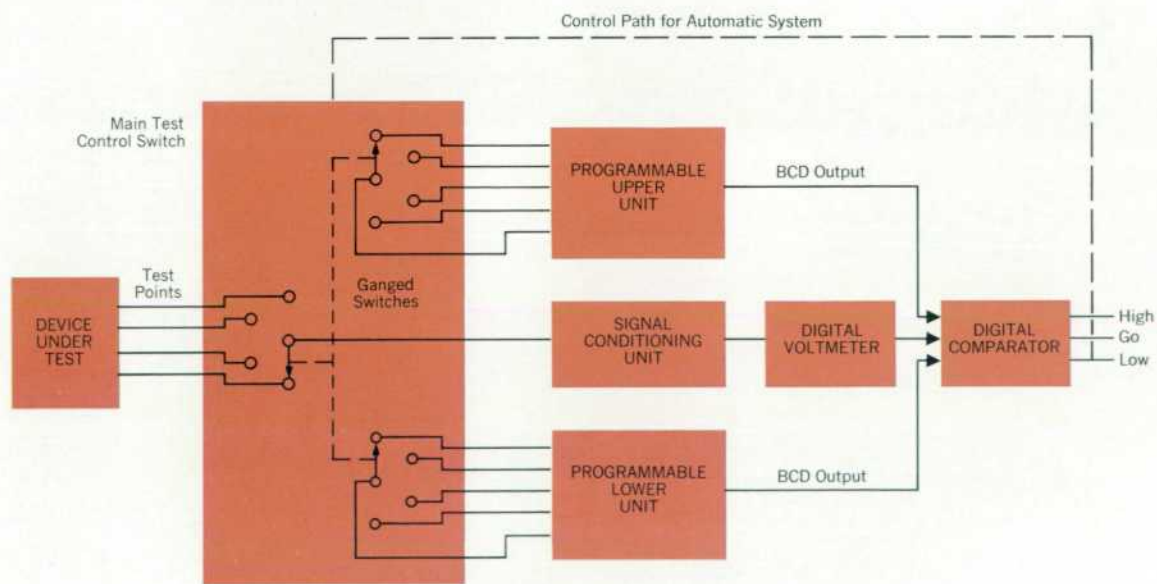

(b)

Fig. 1. A simple HIGH-GO-LOW test system using analog comparison (a) and digital comparison (b). The signal conditioning unit, for example, may be an ac-to-dc converter, an ohms-to-dc converter or a dc amplifier. Input stimuli to the device under test may be controlled by adding another switch bank to the ganged main test switch.



Dee L. Larson

Dee Larson received his B.S. and M.S. degrees in electrical engineering from Utah State University in 1961 and 1963, respectively. He joined the Hewlett-Packard Loveland Division as a development engineer in May 1963. He contributed to the design of the HP Model 3444A DC Multifunction Unit for use with the HP Model 3440A Digital Voltmeter and the HP Model 3439A Digital Voltmeter. He was project engineer for the HP Model 3434A Comparator. Dee is a member of IEEE, Sigma Tau, and Phi Kappa Phi.



Emil E. Olander, Jr.

Ed Olander received his B.S. in electrical engineering from Colorado State University in 1960. Following three years of active duty in the Air Force assigned to NASA, he returned to Colorado State University and received his M.S. in electrical engineering in 1964. He returned to NASA, then joined the Hewlett-Packard Loveland Division in 1966 on the 3434A project. Ed is a member of IEEE, Sigma Tau, Eta Kappa Nu, and Phi Kappa Phi.

Basic System

Two diagrams, Fig 1, show the functional blocks required for simple High-Go-Low systems using either an analog comparator or a digital comparator. For these systems, the measurement test points are connected to a main test control switch. For simplicity, assume this switch to be a manually controlled multi-position rotary switch. This switch changes from one test point to another and controls the upper and lower limit generators so that they can provide appropriate inputs to the comparator for each test.

If the main test control switch is replaced by a stepping switch or a scanner, the High-Go-Low outputs may be used as control signals to automate the system. To make the system more versatile, the main test control switch can also be designed to control the inputs to the device under test.

A new, high-speed, multi-function, dual-limit tester, the HP Model 3434A Comparator, Fig. 2, is based upon the concepts shown in Fig. 1. It has been designed to bridge the gap between computerized limit-test systems and manual categorizing systems. The comparator offers the opportunity to automate testing procedures at low cost while maintaining flexibility.

How it Works

The basic concept behind the circuits of the HP Model 3434A is similar to that of the ramp-type digital volt-

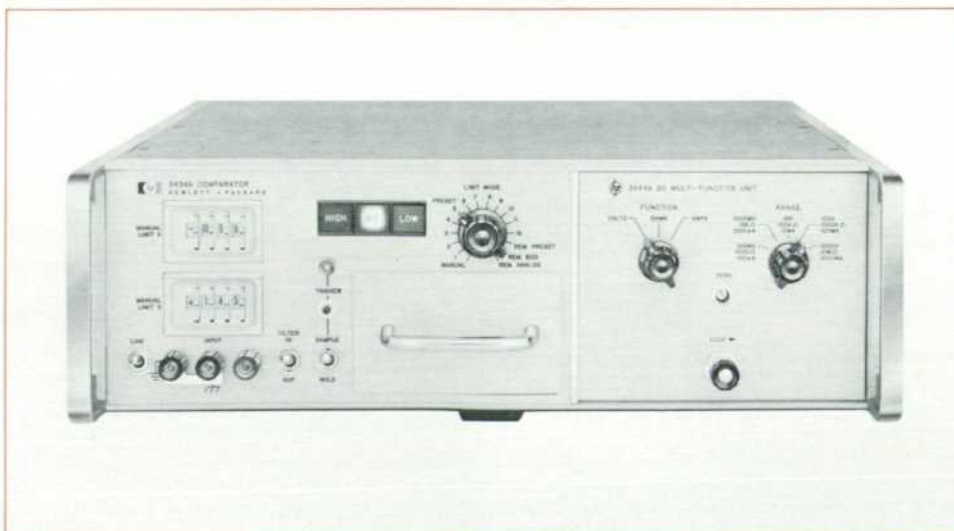

Fig. 2. This new, HP Model 3434A Comparator, designed for production testing, incoming inspection or quality control permits a choice of function and range through the use of plug-ins.

SPECIFICATIONS

HP Model 3434A Comparator

FUNCTIONS: Provides HIGH-GO-LOW testing for dc volts, ac volts, dc current and ohms with the appropriate plug-in (Table I). Comparisons up to 15 times per second.

PERFORMANCE RATING

ACCURACY: (From +15°C to +40°C for all accuracy specifications.)

LIMITS SELECTED BY MANUAL THUMBWHEELS, PRESET LIMITS OR REMOTE BCD

DC VOLTAGES: 10 V, 100 V and 1000 V ranges: $\pm 0.02\%$ of reading $\pm 0.03\%$ of full scale.
100 mV and 1000 mV ranges: $\pm 0.05\%$ of reading $\pm 0.03\%$ of full scale.

AC VOLTAGES: 10 V, 100 V and 1000 V ranges 50 Hz to 20 kHz: $\pm 0.08\%$ of reading $\pm 0.06\%$ of full scale.
20 kHz to 50 kHz: $\pm 0.12\%$ of full scale at 50 kHz to $\pm 0.3\%$ of full scale at 100 kHz.

RESISTANCE: 1000 Ω , 10 k Ω , 100 k Ω and 1000 k Ω ranges: $\pm 0.2\%$ of reading $\pm 0.03\%$ of full scale.

10 M Ω range: $\pm 0.8\%$ of reading $\pm 0.03\%$ of full scale.

CURRENT: 100 μ A, 1000 μ A, 10 mA, 100 mA and 1000 mA ranges: $\pm 0.15\%$ of reading $\pm 0.04\%$ of full scale.

RESOLUTION: Comparators: Better than $\pm 0.01\%$ of full scale.
LIMITS: Remote Analog: Resolution of external analog source being used.

Manual Thumbwheel: 0.1% of full scale.

Preset Limits: 0.1% of full scale.

Remote BCD: 0.1% of full scale.

RESPONSE TIME

DC VOLTAGE: 10 V, 100 V and 1000 V ranges.

Filter in: 240 ms to 99.98% of final value.

Filter out: 140 ms to 99.98% of final value.

100 mV and 1000 mV ranges: Less than 1 s to within 99.95% of final value for full-scale step function.

AC VOLTAGE: 10 V, 100 V and 1000 V ranges: Achieves specified accuracy within 3 s; allow an extra second for recovery when overloaded.

RESISTANCE: 1000 Ω , 10 k Ω , 100 k Ω and 1000 k Ω ranges: less than 1 s to within 99.95% of final value.
10 M Ω range: Less than 5 s to within 99.95% of final value.

CURRENT, ALL RANGES: Less than 1 s to within 99.95% of final value for a full-scale step function.

INPUT CHARACTERISTICS

RESISTANCE (DC): Main input terminals: 10.2 M Ω on all ranges of dc voltage.
Remote analog inputs: 100 k Ω .

IMPEDANCE (AC): 10 M Ω shunted by 20 pF nominal on all ac ranges (3445A, 3446A).

INPUT FILTER AC REJECTION: 10 V, 100 V and 1000 V ranges: Filter in: 30 dB at 60 Hz increasing at 12 dB/octave.
Filter out: 15 dB at 60 Hz increasing at 6 dB/octave.

OUTPUTS

COMPARISON INDICATIONS: HIGH, GO and LOW states are indicated by front-panel lights. Contact closures are provided on the rear panel for each indication. Storage holds the previous reading until the next comparison is completed.

COMPARISON COMPLETE SIGNAL: Reed switch contact closure.

GENERAL

POWER: 115/230 V $\pm 10\%$, 50 to 1000 Hz, 30 W.

PRICE: HP 3434A, Basic Unit, \$1575.00

PLUG-INS:

HP 11084A, Programmer, \$225.00

HP 3411A, Range Selector, \$40.00

HP 3422A, Automatic Range Selector, \$135.00

HP 3443A, High Gain/Auto Range Unit, \$450.00

HP 3444A, DC Multi-Function Unit, \$575.00

HP 3445A, AC/DC Range Unit, \$525.00

HP 3446A, AC/DC Remote Unit, \$575.00

MANUFACTURING DIVISION:

LOVELAND DIVISION

P. O. Box 301

815 Fourteenth Street S.W.

Loveland, Colorado 80537

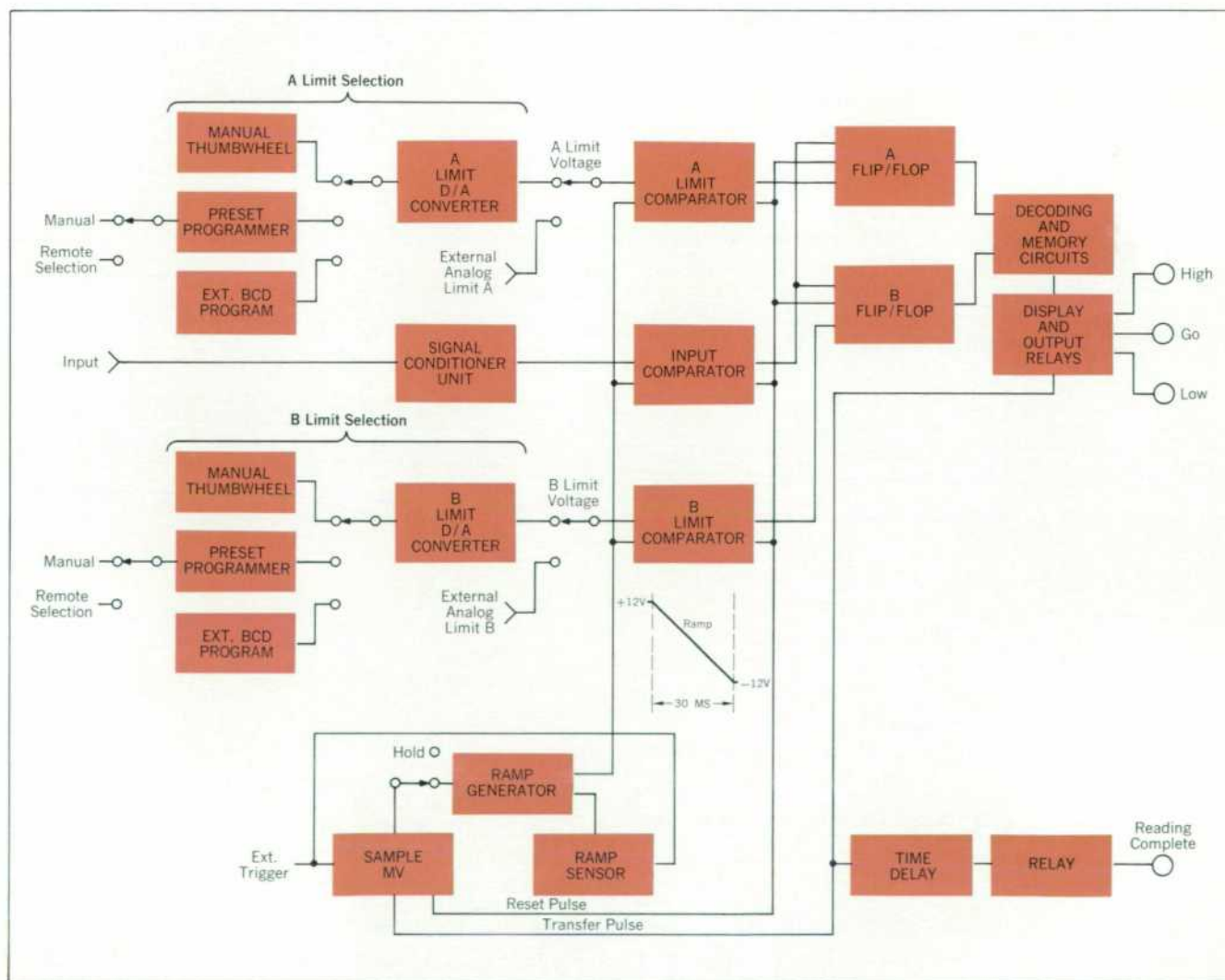

Fig. 3. The signal conditioning unit in the HP 3434A Comparator is one of the plug-in units. HIGH, GO and LOW indications are lighted indicators on the front panel.

meters currently in use by HP. The HP Model 3434A generates a linear ramp whose amplitude is compared to three analog voltages by three comparators. Two of these voltages are the limit voltages and the other is the dc voltage output from the signal conditioning unit, Fig. 3. Each of the comparators changes state when the ramp voltage becomes more negative than their respective analog voltages. The time sequence of the resulting comparator pulses determines the state of flip flops A & B. The state of these flip flops at the end of the ramp is decoded and displayed as High, Go or Low: High, mean-

Setting Test Limits

The analog limits for the comparators are either generated internally in the Model 3434A or provided from external sources. The external source may be any external dc analog source for example, any standard, or other source of dc voltage.

Internally generated analog voltages are produced by two programmable reference supplies. These two references may be controlled in any of three ways—with front panel thumbwheel switches, remotely using BCD code (1, 2, 4, 8), or by a preset programmer with which

Table I Plug-in Functions

Function	3441A Range Selector	3442A Automatic Range Selector	3443A High Gain/ Auto Range Unit	3444A DC Multifunction Unit	3445A AC/DC Range Unit	3446A AC/DC Remote Unit
AC Volts 10 V to 1000 V					X	X
DC Volts 10 V to 1000 V	X	X	X	X	X	X
DC Volts 100 mV to 1000 V			X	X		
DC Amps				X		
Ohms				X		
Manual ranging	X	X	X	X	X	X
Floating input	X	X	X	X	X	X
Remote ranging		X	X		X	X
Remote function						X

ing the output of the signal conditioning unit is more positive than either of the two limits; Low, the signal is more negative than either limit; Go, the signal is between the two limits. In Fig. 4, the indication would be Go, which is displayed until the next measurement is completed and ready to display.

Signal conditioning units are the same plug-in units that are used with the HP Model 3440A Digital Voltmeter, Table I. Functional capabilities include ac volts, dc volts, resistance and dc current.

12 pair of limits may be selected. The preset programmer uses small jumper wires which plug into holes in a printed circuit board, Fig. 5, for flexible program selection. Polarity and the three significant digits for each limit may be selected.

Function and range may also be controlled with the preset programmer, to the extent that the chosen signal conditioning plug-in units have remote capabilities. The limits programmed into the preset programmer may be selected either manually or remotely with a single line for each limit pair.

Where added limit selection flexibility is required, either remote BCD (1, 2, 4, 8) code may be used to select limits or two analog voltages may be supplied as limits A and B. In both of these modes of operation, function and range may also be remotely selected if the signal conditioning plug-in has remote capabilities.

To illustrate the use of the BCD mode (1, 2, 4, 8 code) consider the programming of limit 'A'. To program limit 'A', for example, a polarity line and three groups (one for each of the three digits) of four lines each will control the value. The appropriate lines are selected by contact closures to ground or, in a like manner, by a transistor switch. To explain the programming operation in a more detailed manner, consider the programming of a single digit to a seven.

There are four lines to control the digit. For each line a corresponding weight is given, the weighted value being the BCD Code of 1, 2, 4, 8. Thus to program the desired value of seven, lines corresponding to 1, 2, and 4 are selected by bringing these three lines to ground potential.

Under this mode of operation, the number of different limit pairs that may be selected is controlled by the external programming device (a card reader, for example). All lines needed in this remote BCD mode including external triggering are available at a single 44 pin connector on the rear panel.

Using the System

In a typical production situation, a test station (Fig. 6) was designed to test printed circuit cards for the HP Model 427A Multi-Function Meter. This test station automatically sequences to the next test if a 'Go' indication is obtained and stops if a 'High' or 'Low' is obtained.

As the test advances, the input stimulus is changed, new preset limits are selected, and the input test points

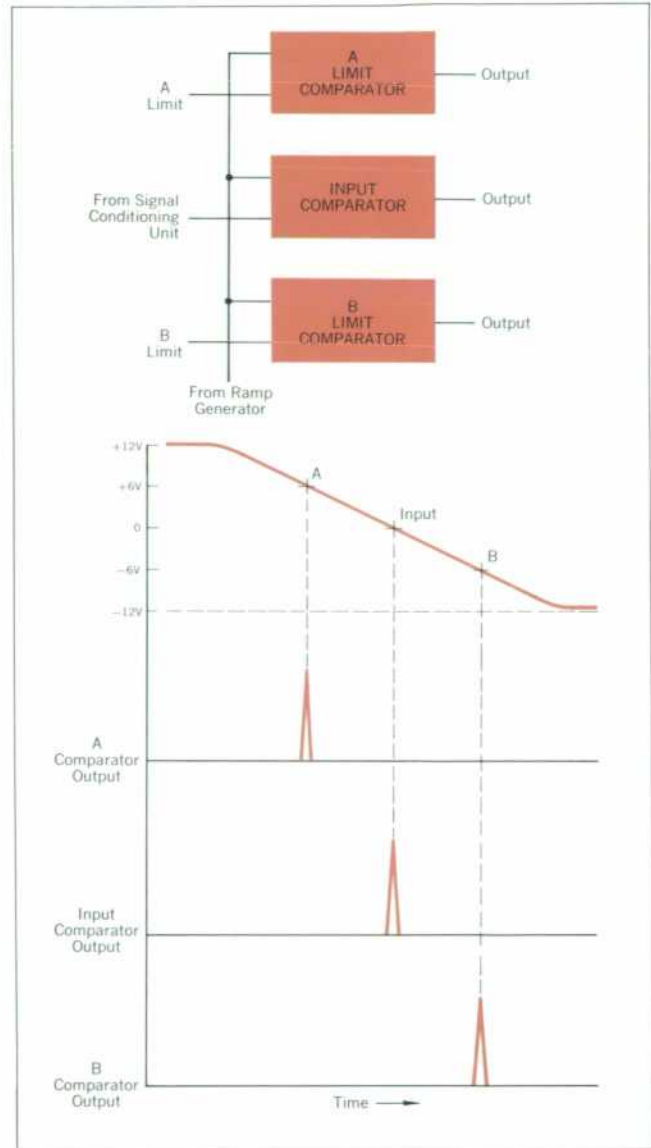

Fig. 4. Time sequence of the comparators. In this example, the A limit voltage has been set to +6 volts, the B limit voltage is -6 volts and the input voltage is 0 volts. When the ramp voltage, reaches +6, 0 and -6 volts in that order, the A limit comparator, input comparator and B limit comparator generate trigger pulses in the same sequence as shown.

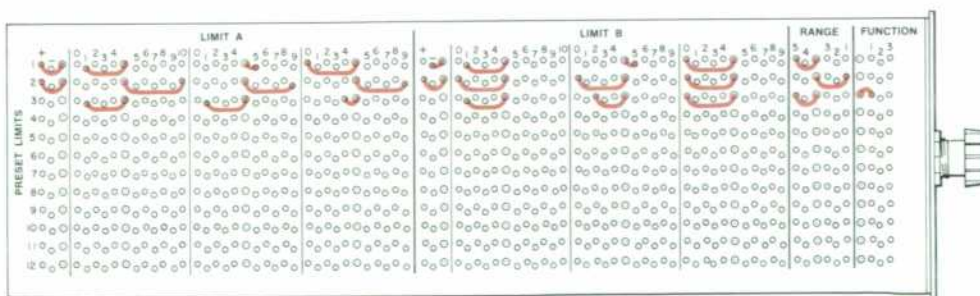

Fig. 5. Up to 12 tests may be preset using the programmer plug-in. Upper and lower limits, polarity, range and function are set up using jumper wires.



Fig. 6. Critical voltages on printed circuit boards are checked with the Comparator. Limits are set with the manual thumbwheel switches.



Fig. 7. Testing digital integrated circuits using a three-wafer switch to select bias levels, input levels and to scan the output of the circuits.

are scanned, all automatically.

Another test station, designed to check static levels from integrated circuits after the application of appropriate stimuli, is shown in Fig. 7. This test station uses a manual switch which controls stimuli, bias levels, and selects scan points.

Categorizing is readily done by monitoring one input and scanning limit pairs until a 'Go' is obtained.

Acknowledgments

A good part of the mechanical design as well as some of the electrical design was handled by Quentin McClure. Karl Waltz assisted in training of the production people in the use of the instrument and in the transfer of the instrument from R & D into production. The authors would like to thank Paul Baird for his assistance and guidance on the project. ■

HEWLETT-PACKARD JOURNAL  AUGUST 1967 Volume 18 • Number 12

TECHNICAL INFORMATION FROM THE LABORATORIES OF THE HEWLETT-PACKARD COMPANY PUBLISHED AT 1501 PAGE MILL ROAD, PALO ALTO, CALIFORNIA 94304
 Editorial Staff: F. J. BURKHARD, R. P. DOLAN, L. D. SHERGALIS, R. H. SNYDER Art Director: R. A. ERICKSON